

**Full bridge  
Series & SiC parallel diodes  
MOSFET Power Module**

$V_{DSS} = 1000V$

$R_{DSon} = 450m\Omega$  typ @  $T_j = 25^\circ C$

$I_D = 18A$  @  $T_c = 25^\circ C$

### Application

- Motor control
- Switched Mode Power Supplies
- Uninterruptible Power Supplies

### Features

- **Power MOS 7<sup>®</sup> MOSFETs**
  - Low  $R_{DSon}$
  - Low input and Miller capacitance
  - Low gate charge
  - Avalanche energy rated
- **Parallel SiC Schottky Diode**
  - Zero reverse recovery
  - Zero forward recovery
  - Temperature Independent switching behavior
  - Positive temperature coefficient on VF
- Kelvin source for easy drive
- Very low stray inductance
  - Symmetrical design
  - Lead frames for power connections
- Internal thermistor for temperature monitoring
- High level of integration

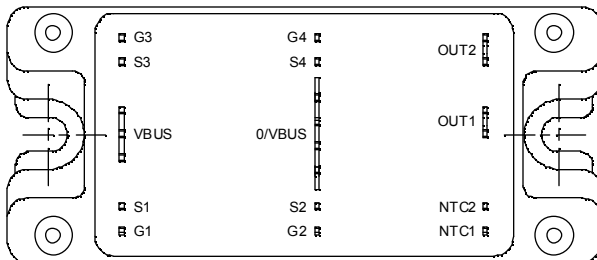
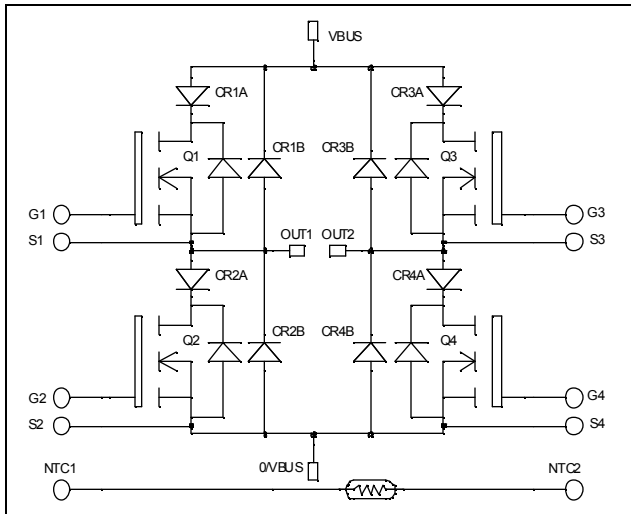

### Benefits

- Outstanding performance at high frequency operation
- Direct mounting to heatsink (isolated package)
- Low junction to case thermal resistance
- Solderable terminals both for power and signal for easy PCB mounting
- Low profile
- RoHS Compliant

### Absolute maximum ratings

Symbol	Parameter	Max ratings	Unit
$V_{DSS}$	Drain - Source Breakdown Voltage	1000	V
$I_D$	Continuous Drain Current	$T_c = 25^\circ C$	18
		$T_c = 80^\circ C$	14
$I_{DM}$	Pulsed Drain current	72	A
$V_{GS}$	Gate - Source Voltage	$\pm 30$	V
$R_{DSon}$	Drain - Source ON Resistance	540	$m\Omega$
$P_D$	Maximum Power Dissipation	$T_c = 25^\circ C$	357
$I_{AR}$	Avalanche current (repetitive and non repetitive)	18	A
$E_{AR}$	Repetitive Avalanche Energy	50	mJ
$E_{AS}$	Single Pulse Avalanche Energy	2500	

**CAUTION:** These Devices are sensitive to Electrostatic Discharge. Proper Handling Procedures Should Be Followed. See application note APT0502 on [www.microsemi.com](http://www.microsemi.com)

All ratings @  $T_j = 25^\circ\text{C}$  unless otherwise specified

**Electrical Characteristics**

Symbol	Characteristic	Test Conditions	Min	Typ	Max	Unit
$I_{DSS}$	Zero Gate Voltage Drain Current	$V_{GS} = 0\text{V}, V_{DS} = 1000\text{V}$			100	$\mu\text{A}$
		$V_{GS} = 0\text{V}, V_{DS} = 800\text{V}$			500	
$R_{DS(on)}$	Drain – Source on Resistance	$V_{GS} = 10\text{V}, I_D = 9\text{A}$		450	540	$\text{m}\Omega$
$V_{GS(th)}$	Gate Threshold Voltage	$V_{GS} = V_{DS}, I_D = 2.5\text{mA}$	3		5	V
$I_{CSS}$	Gate – Source Leakage Current	$V_{GS} = \pm 30\text{V}, V_{DS} = 0\text{V}$			$\pm 100$	nA

**Dynamic Characteristics**

Symbol	Characteristic	Test Conditions	Min	Typ	Max	Unit
$C_{iss}$	Input Capacitance	$V_{GS} = 0\text{V}$		4350		pF
$C_{oss}$	Output Capacitance	$V_{DS} = 25\text{V}$		715		
$C_{rss}$	Reverse Transfer Capacitance	$f = 1\text{MHz}$		120		
$Q_g$	Total gate Charge	$V_{GS} = 10\text{V}$		154		nC
$Q_{gs}$	Gate – Source Charge	$V_{Bus} = 500\text{V}$		26		
$Q_{gd}$	Gate – Drain Charge	$I_D = 18\text{A}$		97		
$T_{d(on)}$	Turn-on Delay Time	<b>Inductive switching @ 125°C</b> $V_{GS} = 15\text{V}$ $V_{Bus} = 667\text{V}$ $I_D = 18\text{A}$ $R_G = 5\Omega$		10		ns
$T_r$	Rise Time			12		
$T_{d(off)}$	Turn-off Delay Time			121		
$T_f$	Fall Time			35		
$E_{on}$	Turn-on Switching Energy	<b>Inductive switching @ 25°C</b> $V_{GS} = 15\text{V}, V_{Bus} = 667\text{V}$ $I_D = 18\text{A}, R_G = 5\Omega$		383		$\mu\text{J}$
$E_{off}$	Turn-off Switching Energy			380		
$E_{on}$	Turn-on Switching Energy	<b>Inductive switching @ 125°C</b> $V_{GS} = 15\text{V}, V_{Bus} = 667\text{V}$ $I_D = 18\text{A}, R_G = 5\Omega$		627		$\mu\text{J}$
$E_{off}$	Turn-off Switching Energy			451		

**Series diode ratings and characteristics**

Symbol	Characteristic	Test Conditions	Min	Typ	Max	Unit
$V_{RRM}$	Maximum Peak Repetitive Reverse Voltage		200			V
$I_{RM}$	Maximum Reverse Leakage Current	$V_R = 200\text{V}$	$T_j = 25^\circ\text{C}$		250	$\mu\text{A}$
			$T_j = 125^\circ\text{C}$		500	
$I_F$	DC Forward Current			30		A
$V_F$	Diode Forward Voltage	$I_F = 30\text{A}$		1.1	1.15	V
		$I_F = 60\text{A}$		1.4		
		$I_F = 30\text{A}$	$T_j = 125^\circ\text{C}$		0.9	
$t_{rr}$	Reverse Recovery Time	$I_F = 30\text{A}$ $V_R = 133\text{V}$ $di/dt = 200\text{A}/\mu\text{s}$	$T_j = 25^\circ\text{C}$		24	ns
			$T_j = 125^\circ\text{C}$		48	
$Q_{rr}$	Reverse Recovery Charge	$I_F = 30\text{A}$ $V_R = 133\text{V}$ $di/dt = 200\text{A}/\mu\text{s}$	$T_j = 25^\circ\text{C}$		33	nC
			$T_j = 125^\circ\text{C}$		150	

**Parallel SiC diode ratings and characteristics**

<i>Symbol</i>	<i>Characteristic</i>	<i>Test Conditions</i>		<i>Min</i>	<i>Typ</i>	<i>Max</i>	<i>Unit</i>
V <sub>RRM</sub>	Maximum Peak Repetitive Reverse Voltage			1200			V
I <sub>RRM</sub>	Maximum Reverse Leakage Current	V <sub>R</sub> =1200V	T <sub>j</sub> = 25°C		100	400	μA
			T <sub>j</sub> = 150°C		200	2000	
I <sub>F</sub>	DC Forward Current	T <sub>c</sub> = 125°C			10		A
V <sub>F</sub>	Diode Forward Voltage	I <sub>F</sub> = 10A	T <sub>j</sub> = 25°C		1.6	1.8	V
			T <sub>j</sub> = 175°C		2.6	3.0	
Q <sub>C</sub>	Total Capacitive Charge	I <sub>F</sub> = 10A, V <sub>R</sub> = 600V di/dt = 800A/μs			28		nC
Q	Total Capacitance	f = 1MHz, V <sub>R</sub> = 200V			90		pF
		f = 1MHz, V <sub>R</sub> = 400V			66		

**Thermal and package characteristics**

<i>Symbol</i>	<i>Characteristic</i>			<i>Min</i>	<i>Typ</i>	<i>Max</i>	<i>Unit</i>
R <sub>thJC</sub>	Junction to Case Thermal Resistance	Transistor				0.35	°C/W
		Series diode				1.2	
		Parallel diode				1.5	
V <sub>ISOL</sub>	RMS Isolation Voltage, any terminal to case t = 1 min, I <sub>isol</sub> < 1mA, 50/60Hz			2500			V
T <sub>J</sub>	Operating junction temperature range			-40		150	°C
T <sub>STG</sub>	Storage Temperature Range			-40		125	
T <sub>C</sub>	Operating Case Temperature			-40		100	
Torque	Mounting torque	To Heatsink	M5	2.5		4.7	N.m
Wt	Package Weight					160	g

**Temperature sensor NTC** (see application note APT0406 on www.microsemi.com for more information).

<i>Symbol</i>	<i>Characteristic</i>	<i>Min</i>	<i>Typ</i>	<i>Max</i>	<i>Unit</i>
R <sub>25</sub>	Resistance @ 25°C		50		kΩ
B <sub>25/85</sub>	T <sub>25</sub> = 298.15 K		3952		K

$$R_T = \frac{R_{25}}{\exp \left[ B_{25/85} \left( \frac{1}{T_{25}} - \frac{1}{T} \right) \right]}$$

T: Thermistor temperature  
 R<sub>T</sub>: Thermistor value at T

## SP4 Package outline (dimensions in mm)

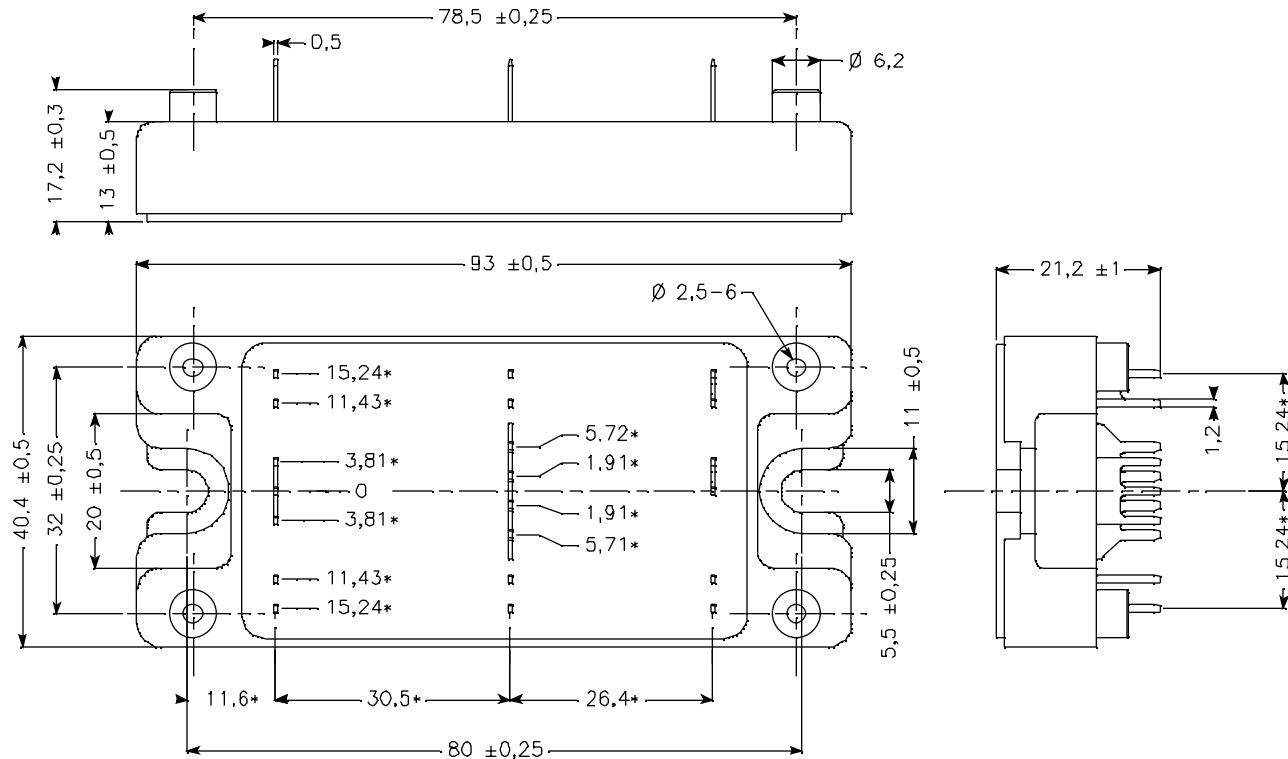

ALL DIMENSIONS MARKED "\*" ARE TOLERANCED AS:  $\pm 0,1$

See application note APT0501 - Mounting Instructions for SP4 Power Modules on [www.microsemi.com](http://www.microsemi.com)

## Typical MOSFET Performance Curve

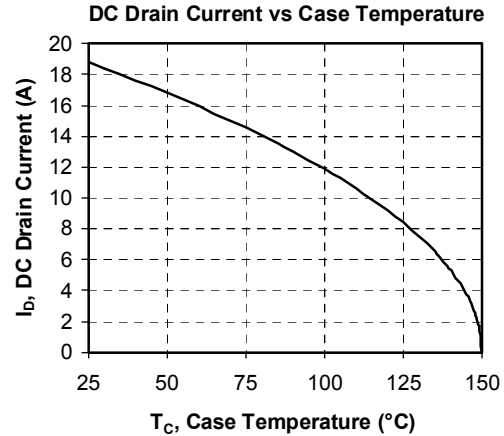
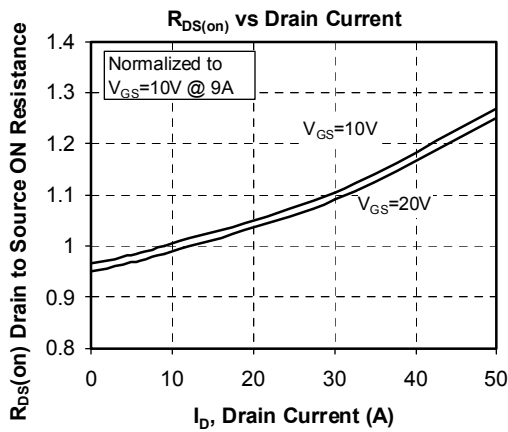
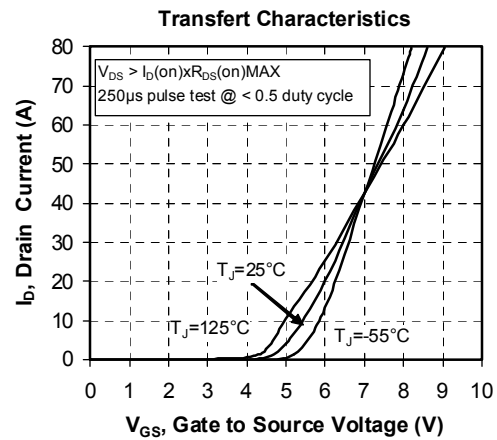
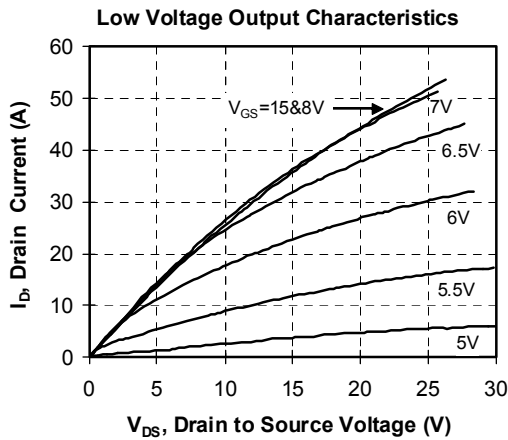
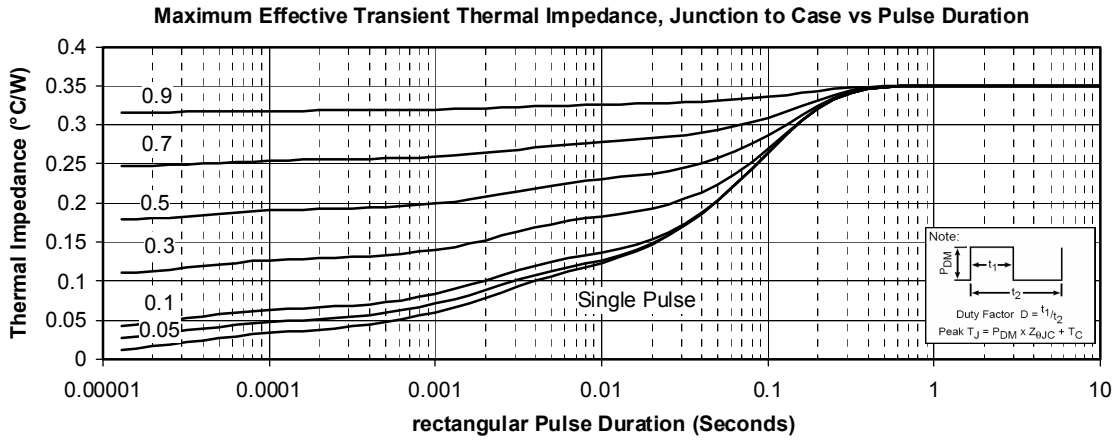

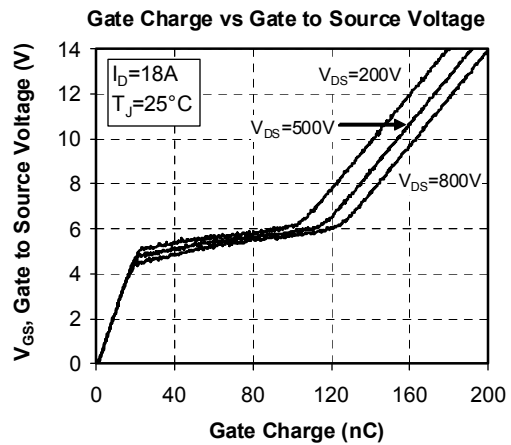
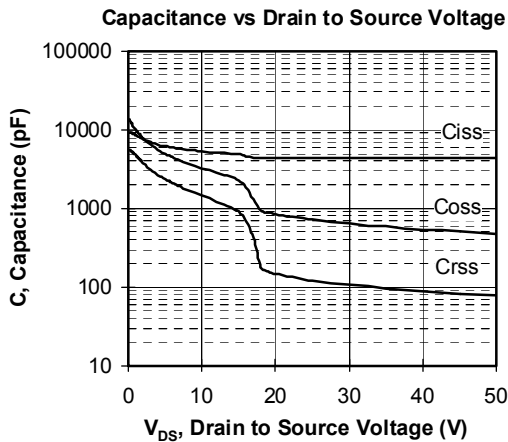
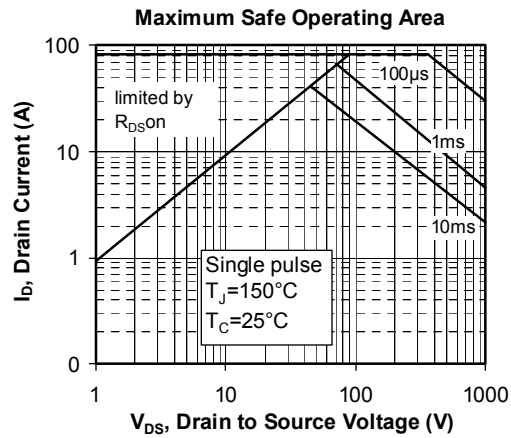
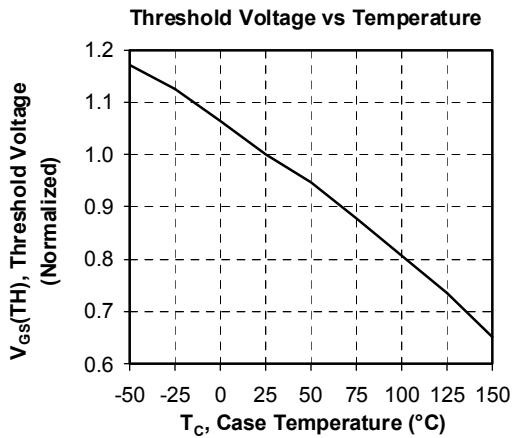
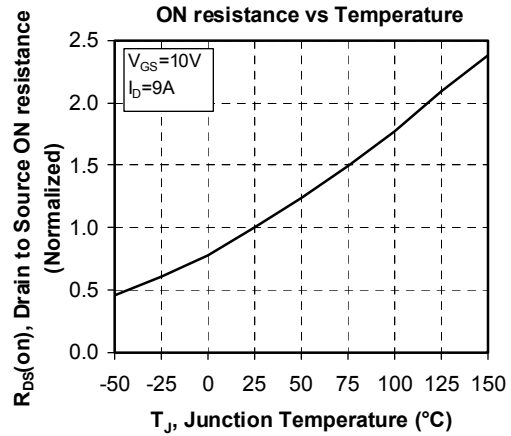
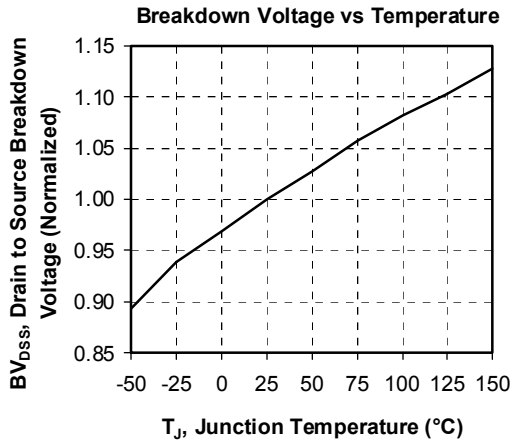

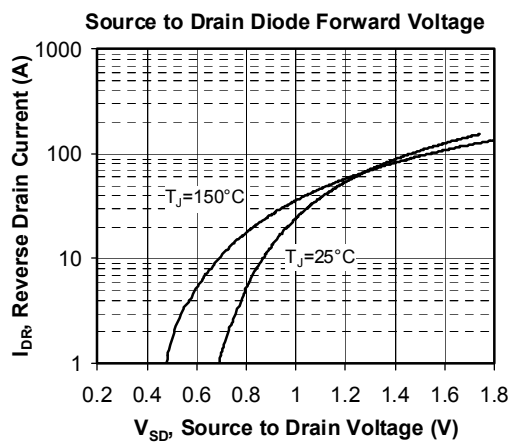
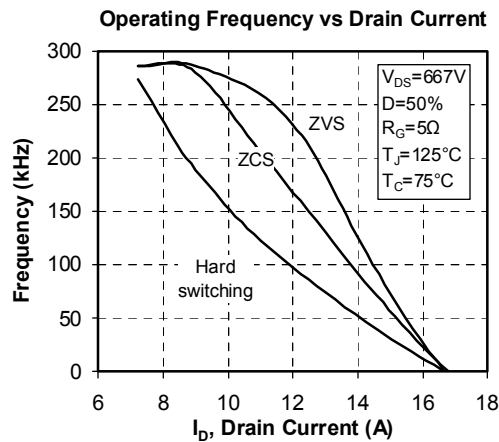
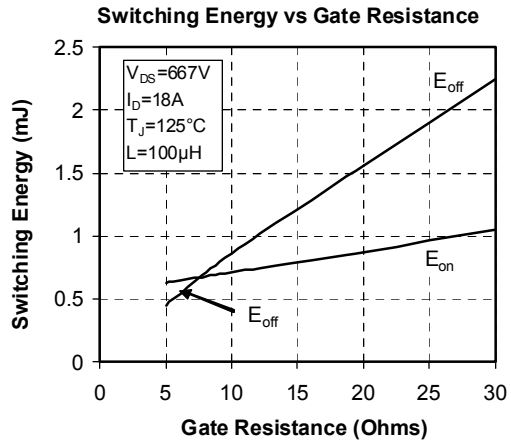
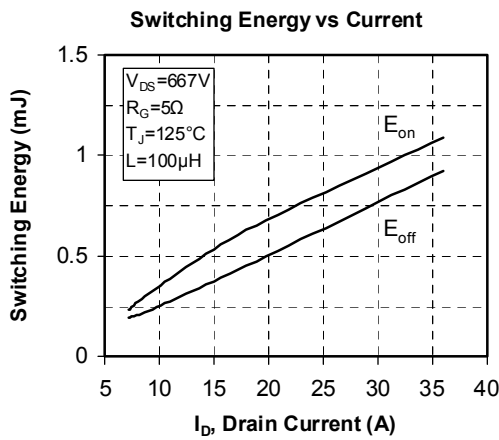
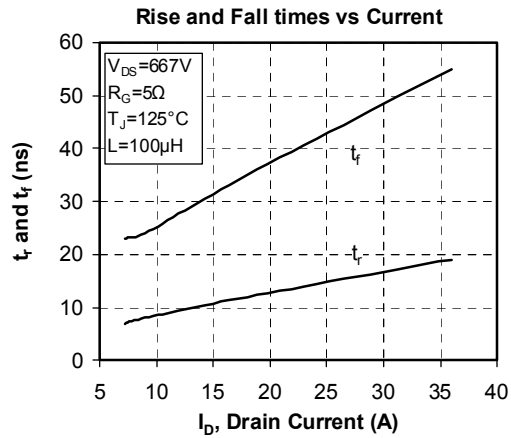
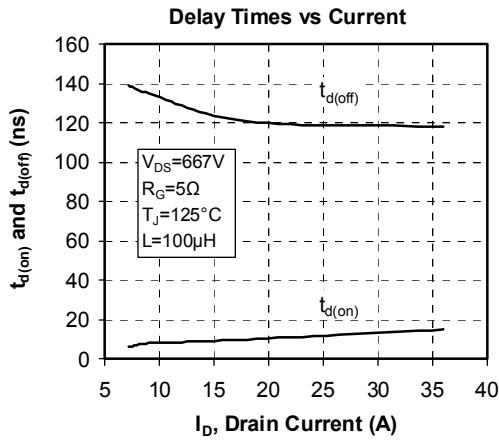

## Typical SiC Diode Performance Curve

Maximum Effective Transient Thermal Impedance, Junction to Case vs Pulse Duration

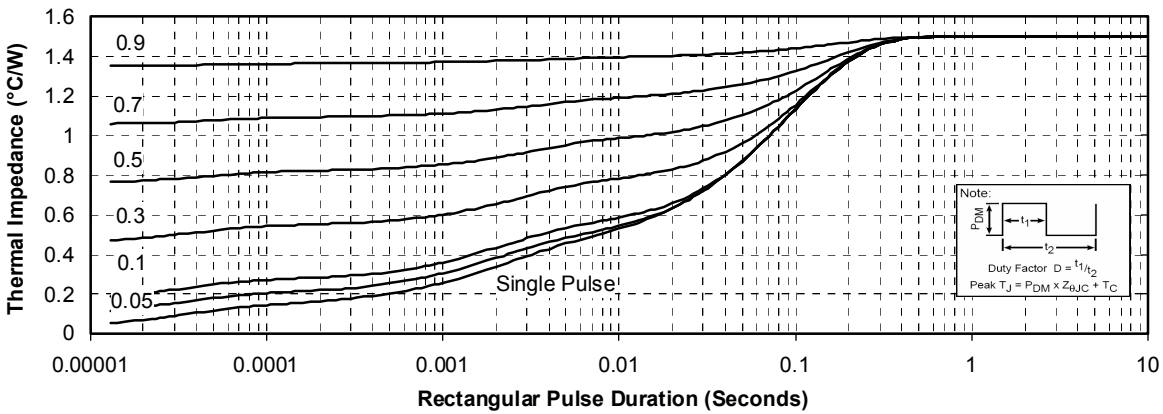

Forward Characteristics

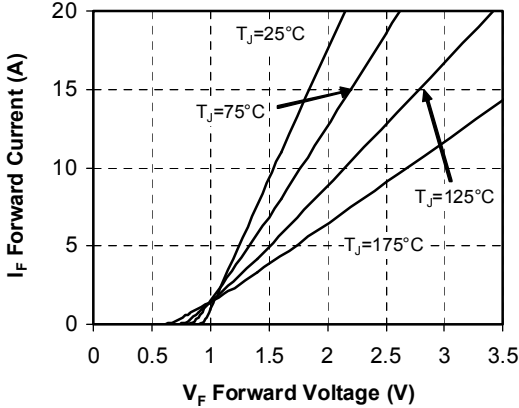

Reverse Characteristics

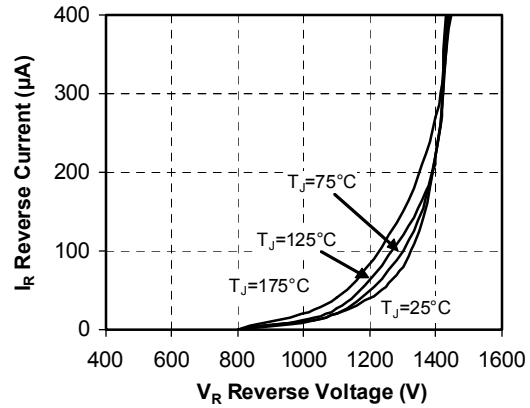

Capacitance vs. Reverse Voltage

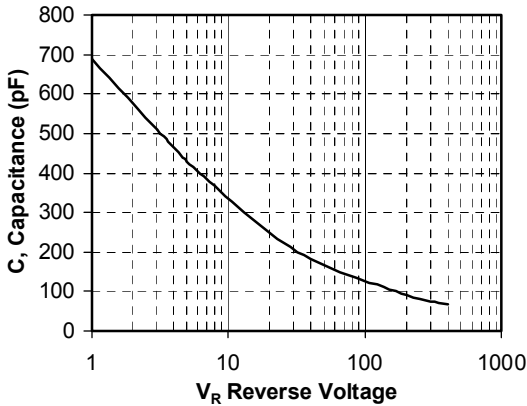

Microsemi reserves the right to change, without notice, the specifications and information contained herein

Microsemi's products are covered by one or more of U.S. patents 4,895,810 5,045,903 5,089,434 5,182,234 5,019,522 5,262,336 6,503,786 5,256,583 4,748,103 5,283,202 5,231,474 5,434,095 5,528,058 and foreign patents. U.S. and Foreign patents pending. All Rights Reserved.